



Specification

Product:	Stylish Lighting System LLS1.0
Model:	LE8832
Version:	A05
Date:	28, Mar, 2018

Content

- ◆ Product Information.....3
- ◆ Essentials.....4
- ◆ Optional Accessories.....5
- ◆ Package Information.....6
- ◆ Contact.....7

Product Information :

Structure

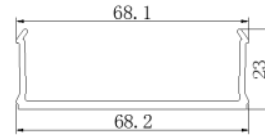
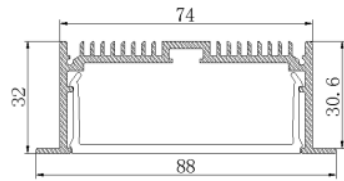

Parameter

Profile	
Installation	Recessed
Material	AL6063-T5
Application	For indoors
Weight	2.67kg/2.5m
Surface	Anodization
Size(mm)	L2500*W88*H32
Qty	1Pc

Diffuser	
Material	Diffused & frosted PC
Transmittance	85%
Size(mm)	L2500*W68.2*H23
Qty	1pc
PC features	The diffuser will extend(shrink) by 0.8mm/M everytime the temperature rises(declines) by 10°C

◆Details

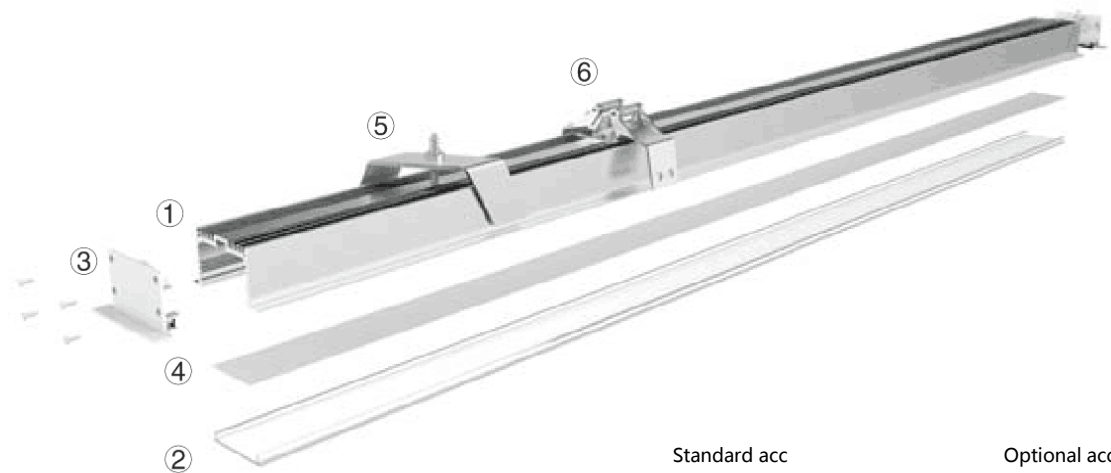

Standard acc





- ① Profile×1 (PR-LE8832)
- ② Diffuser×1 (CV-LE8832)
- ③ End caps×4 (EC-LE8832)
- ④ Recessed buckle (N-shaped) (RN-03)

Optional acc

- ⑤ Flexible strip (D8350-24V-58mm)
- ⑥ Recessed buckle (Butterfly clips) (RB-01)
- ⑦ Power (ESD-V24-100S)

Essential

List : LE8832



Name	Photo	Material	Size (mm)	Surface Processing	Color	Qty
Profile ^①		Al6063-T5	L2500*W88*H32	Silver Anodization	Silver	1pc
Diffuser		PC	L2500*W68.2*H23	Diffused & frosted PC	--	1pc
End cap ^②		Anti-fire PC	L88*W32*H24	Spray paint RAL9006 silver	Silver	4pcs
Recessed buckle (N-shaped)		SPCC	L108.5*W80H40.2	--	--	4pcs

Note:①Profile ,White/Black Powder Coating available on request;

②End caps,Spray paint RAL9005 black/RAL9003 white available on request.

Optional accessories :

list : LE8832

Name/Model	Photo	Material	Size (mm)	Surface Processing	Color	MOQ
Recessed buckle (Butterfly clips)		SPCC	L89.5*W50*H48.5mm	--	--	2pcs
Power supply ^① (ESD-V24-100S)		Three-in-one dimming power (0-10V、PWM、resistance) , size : 390*38*28.5mm, white, 100W				PCS
Flexible strip ^② (D8350-24V-58mm)		Material : FPC , CCT : 2300/2700/3000/4000/5000/6000K, CRI > 80/>95, Voltage:24V, Power : 36W/m, Lumen : 3800Lm/m, PCB width : 58mm, Minimum cutting unit : 100mm,				Reel , 2.5m/reel

Note:①Power supply,Pls check power supply specification sheet for more details;

②Flexible strip,Pls check D8350-24V-58mm specification sheet for more details.

Package information :

The whole package

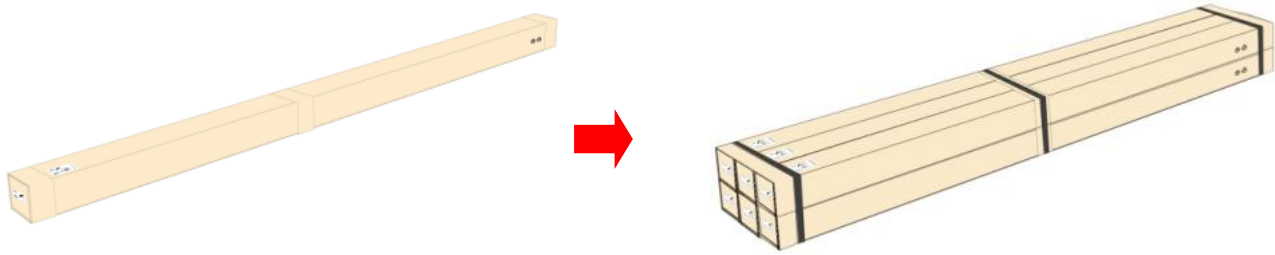

LE8832	Single Package				
	Type	Size(mm)	NW(kg)	GW(kg)	Included
	Packing box	112*50*2580	3.8	4.78	1set (Profile+Diffuser+End caps+N-shaped recessed buckle)
	Bundle Package				
	CBM(m³)	Size(mm)	NW(kg)	GW(kg)	Qty/bundle
	0.072	224*150*2580	22.8	28.68	6Set



Tel : +86-755-2923 1888

E-mail : colors@colorsled.com

Add.: Building A5, Qixing Wisdom Park, Shiyan Youth Road, Bao'an District, Shenzhen, China



www.colorsled.com