

Data Sheet | Item Number: 222-415

CLASSIC Splicing Connector; for all conductor types; max. 4 mm²; 5-conductor;
with levers; gray housing; Surrounding air temperature: max 40°C; 2,50 mm²; gray

<https://www.wago.com/222-415>



Color: ■ gray

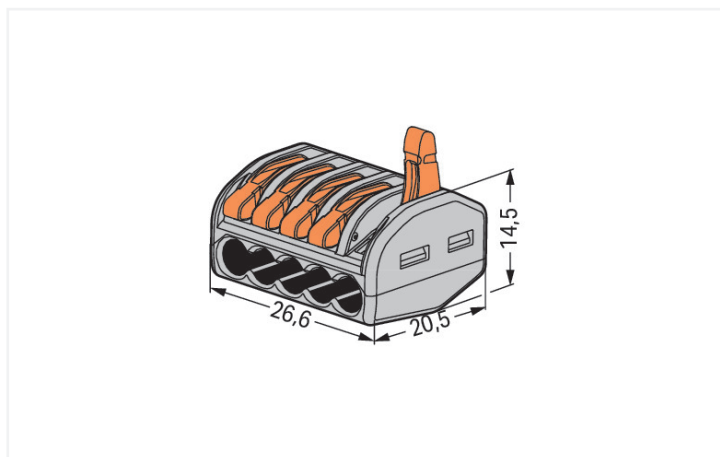

Dimensions in mm

Notes

Safety information	in grounded power lines
--------------------	-------------------------

Electrical data

Ratings per	EN 60664		
Overvoltage category	III	III	II
Pollution degree	3	2	2
Nominal voltage	-	-	400 V
Rated surge voltage	-	-	4 kV
Rated current	-	-	32 A

Connection data

Connection points	5
Total number of potentials	1

Connection 1

Connection technology	CAGE CLAMP®
Actuation type	Lever
Connectable conductor materials	Copper
Solid conductor	0.08 ... 2.5 mm ² / 28 ... 12 AWG
Stranded conductor	0.08 ... 2.5 mm ² / 28 ... 12 AWG
Fine-stranded conductor	0.08 ... 4 mm ² / 28 ... 12 AWG
Strip length	9 ... 10 mm / 0.35 ... 0.39 inches
Wiring direction	Side-entry wiring

Physical data

Width	26.6 mm / 1.047 inches
Height	14.5 mm / 0.571 inches
Depth	20.5 mm / 0.807 inches

Material data

Note (material data)	Information on material specifications can be found here
Color	gray
Flammability class per UL94	V0
Fire load	0.129 MJ
Actuator color	orange
Weight	6.6 g

Environmental requirements

Ambient temperature (operation)	+40 °C
Continuous operating temperature	85 °C

Environmental Product Compliance

RoHS Compliance Status	Compliant, No Exemption
------------------------	-------------------------

Approvals / Certificates

General approvals **Declarations of conformity and manufacturer's declarations**



Approval	Standard	Certificate Name
ENEC 15 UL International Demko A/S	EN 60998	ENEC-01360
UL_Listed_64KA UL International Germany GmbH	UL 467	E201573
UL UL International Germany GmbH	UL 486C	E69654

Approval	Standard	Certificate Name
EU-Declaration of Conformity WAGO GmbH & Co. KG	-	-
UK-Declaration of Conformity WAGO GmbH & Co. KG	-	-

Approvals for marine applications



Approval	Standard	Certificate Name
ABS American Bureau of Shipping	-	18-HG1755093-PDA
DNV GL Det Norske Veritas, Germanischer Lloyd	EN 60998	TAE000015T
LR Lloyds Register	EN 60998	LR22207029TA

1 Compatible Products

1.1 Optional Accessories

1.1.1 Mounting adapter

1.1.1.1 Mounting accessories



Item No.: 222-500
 Mounting carrier; 222 Series; for DIN-35 rail mounting/screw mounting; orange

Installation Notes

Conductor termination

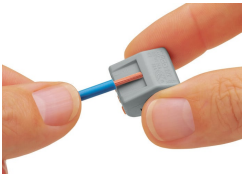

Strip conductor to 9 ... 10 mm (0.35 ... 0.39 inch).

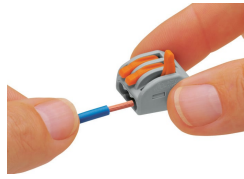

Termination: Lift the lever to open the clamping unit and insert a stripped conductor.

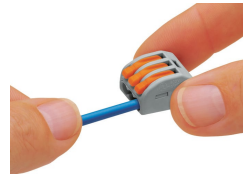

Then, lower the lever to close the clamp.

Testing

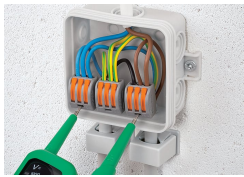

Testing via Profi-LED+ voltage tester (206-806).

Application

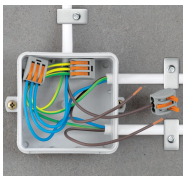

Wiring fine-stranded conductors in junction boxes.



Custom low-voltage lighting system

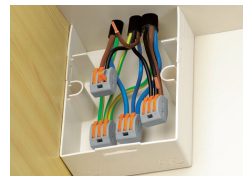

Connecting pre-wired and pre-fabricated components (e.g., in mobile homes).

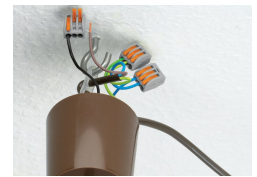

Lighting fixture connection with fine-stranded wires and power feed

